

Product Data Sheet



LE-VPP 125R-FI

EAN 4047526289225

ID 289223

Pressed steel swivel castor with top plate fitting and 'stop-fix' brake, Wheel with standard solid rubber tyres, with synthetic rim

Bracket:

Made of pressed steel, with double ball bearing in the swivel head, ball protection by the special top plate and ball disc design. The special Blickle dynamic riveting process of the swivel head results in minimal swivel head play and smooth rolling characteristics with an increased service life achieved by the work hardening of the ball race grooves. Bolted wheel axle. Zinc-plated, blue-passivated, Cr6-free.



Wheels:

Made of standard solid rubber, very high operational comfort, low-noise operation, very good floor preservation, PAH conform acc. to EU directive 2005/69/EC.

Tread/tyre: Made of standard solid rubber.

Tread colours black

Wheel centre/rim:

Made of high-quality, impact-resistant polypropylene. Pressed-on tyre.

Wheel centre colour: black

Rolling resistance

■ ■ □ □ □ Satisfactory

Operating noise

■ ■ ■ ■ □ Very good

Floor surface preservation













■ ■ ■ ■ □ Very good

Ташев-Галвинг ООД
www.tashev-galving.com

Product Data Sheet



Technical data

Plate size		100 x 85
Bolt hole spacing		80 x 60
Bolt hole Ø		9
Wheel Ø		125 mm (D)
Wheel width		37,5 mm (T2)
Load capacity		100 kg
Total height		150 mm (H)
Offset swivel castor		40 mm
unit weight		1 kg
Temperature resistance		-20 ° C
Temperature resistance to		60 ° C
tread and tyre hardness		80° Shore A
Bearing type:		Roller bearing

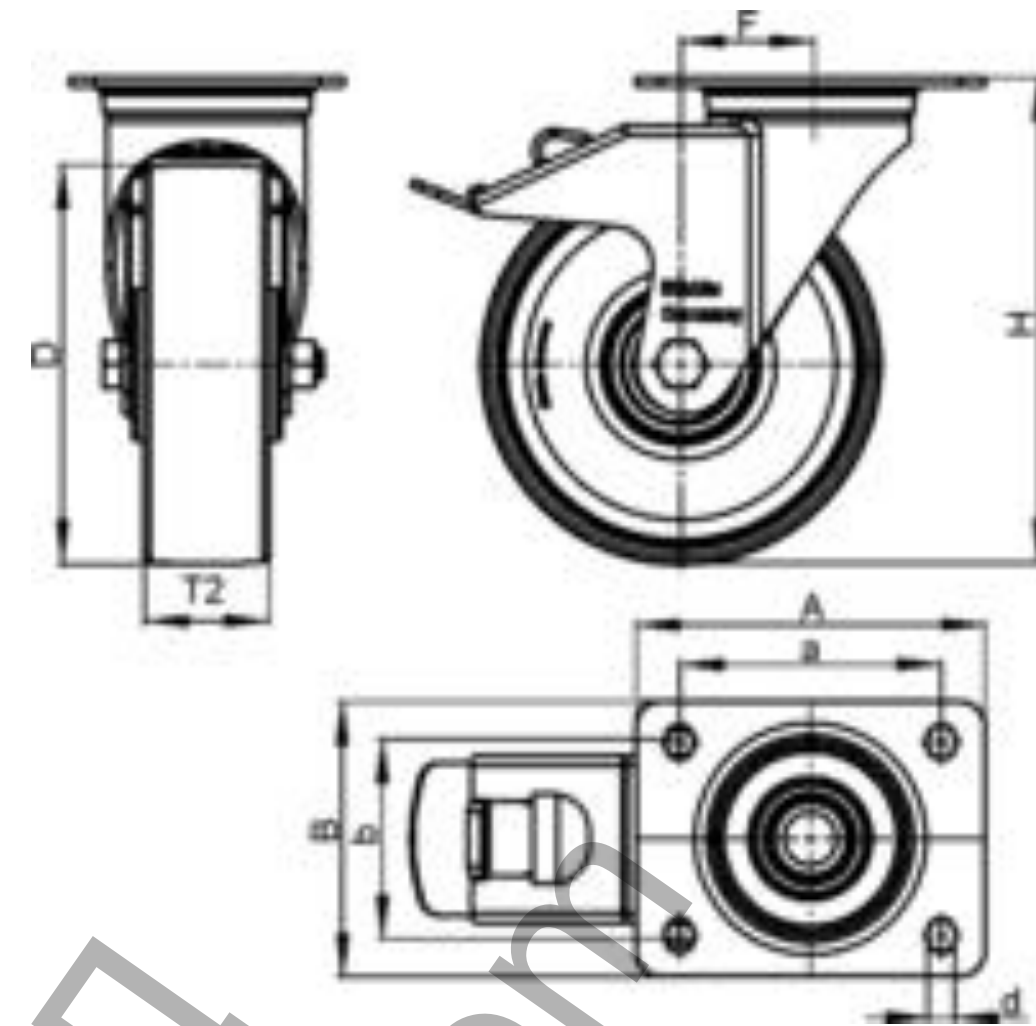

Ташев-Галвинг ООД
www.tashev-galving.com